

Mechanical Dimensions: Inches [mm]

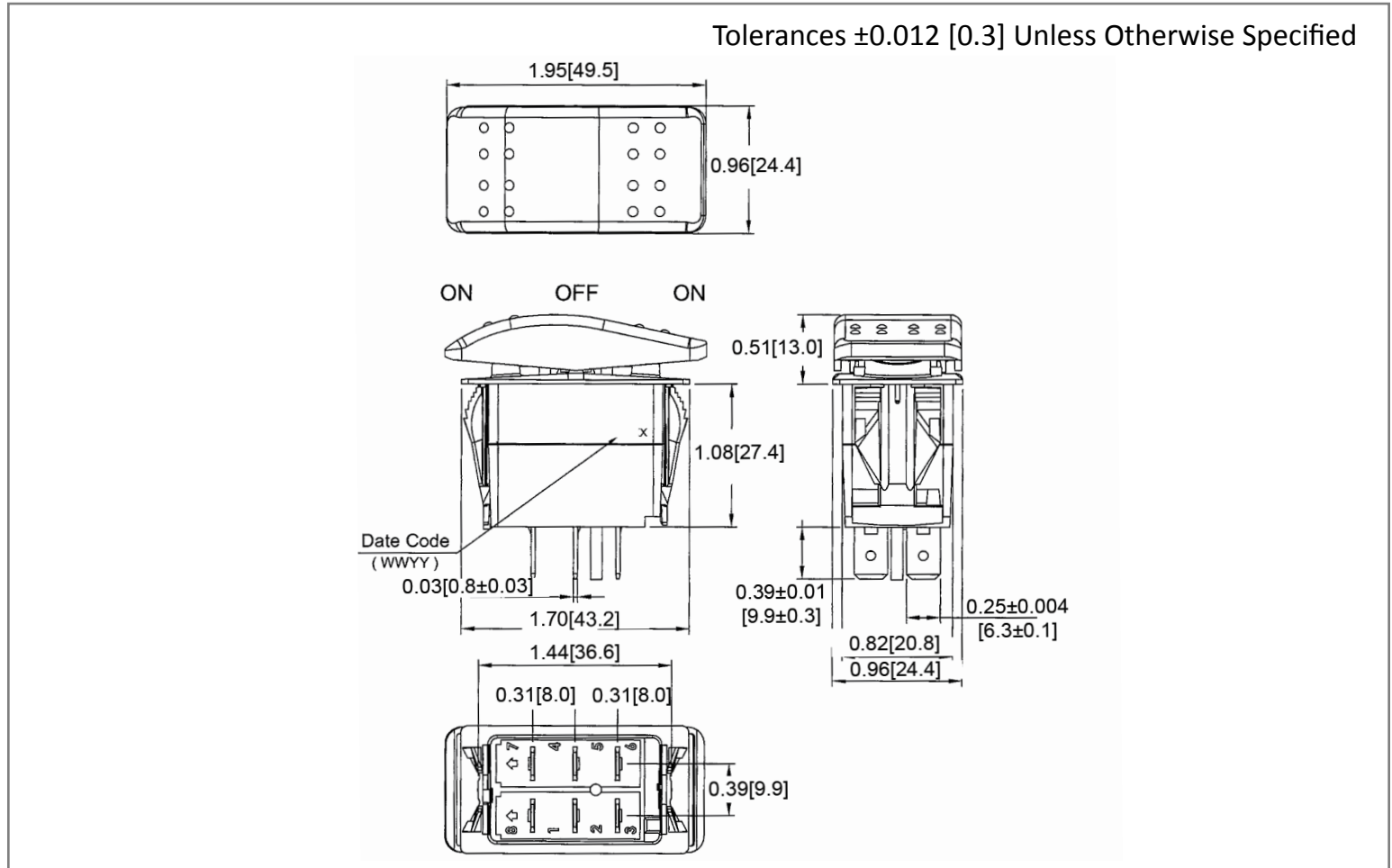

Mounting Hole

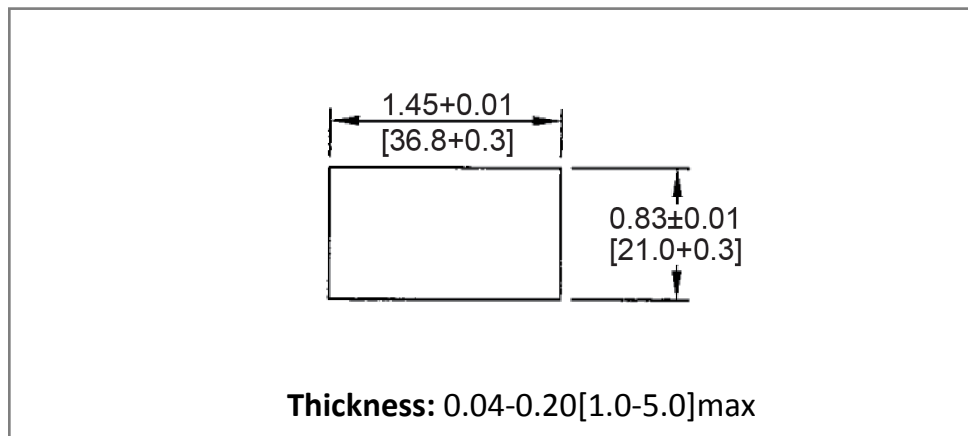

Circuit Diagram

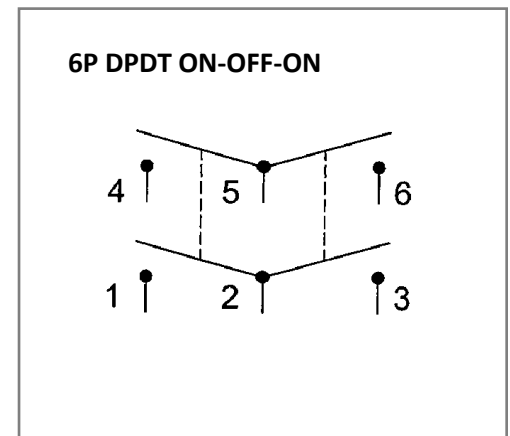

Electrical Specifications

DC Rating	21A 14V DC
AC Rating	20A 125V AC, 10A 250V AC
Contact Resistance	50m ohm Max
Insulation Resistance	DC 500V 100M ohm Min
Dielectric Strength	AC 1500V 1 minute

Material Specifications

Frame	Black, Nylon 66 (94V-2)
Actuator	Red, Nylon 66 (94V-2)
Terminals	Silver plated copper
Ingress Protection	IP56
Operation Temperature	-25°C~85°C

Rev	Date of issue	Revision Notes	Designed	Approved
B	06-25-2021	Initial Drawing	RC	OF