

## Mechanical Dimensions: Inches [mm]

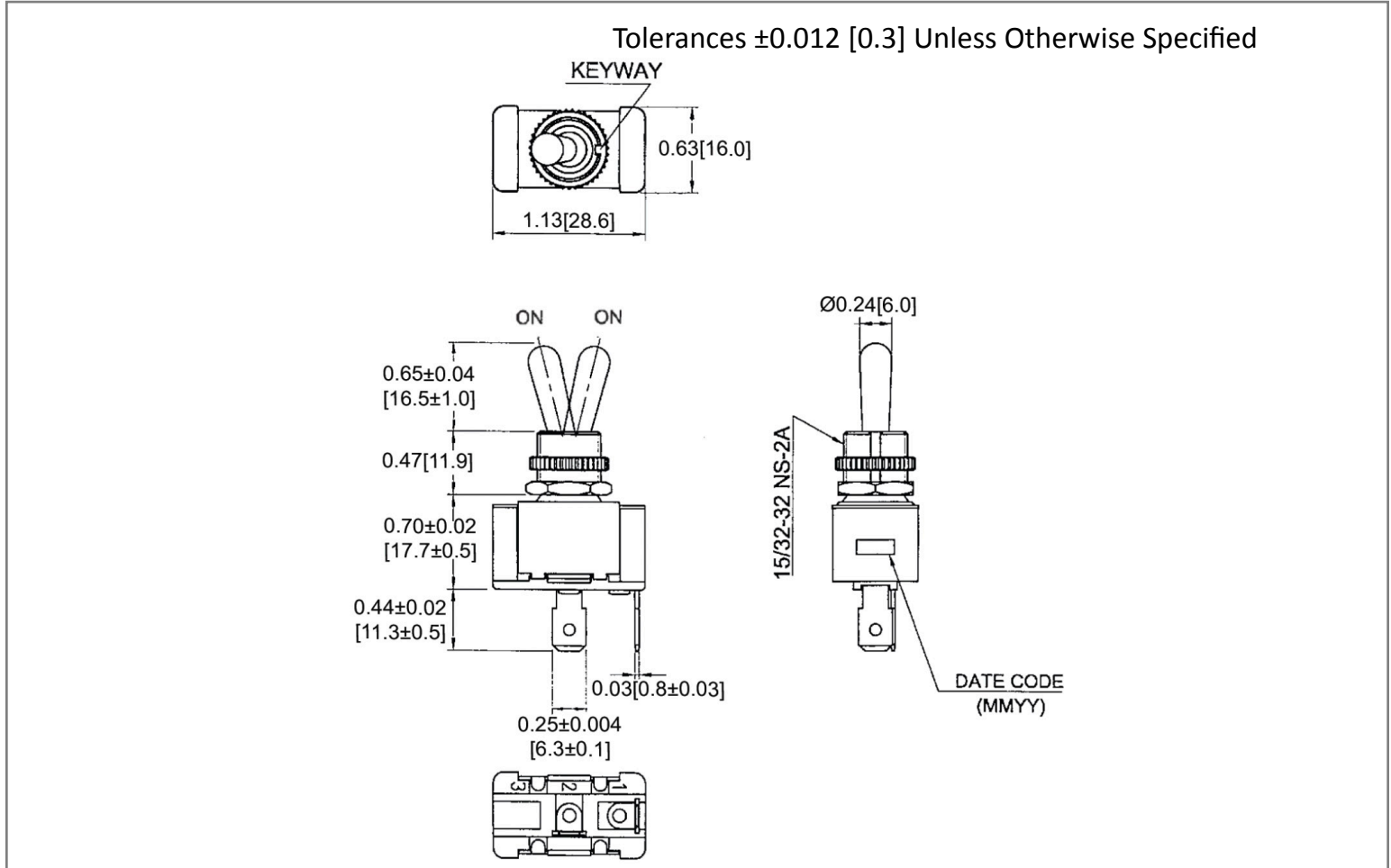

## Mounting Hole

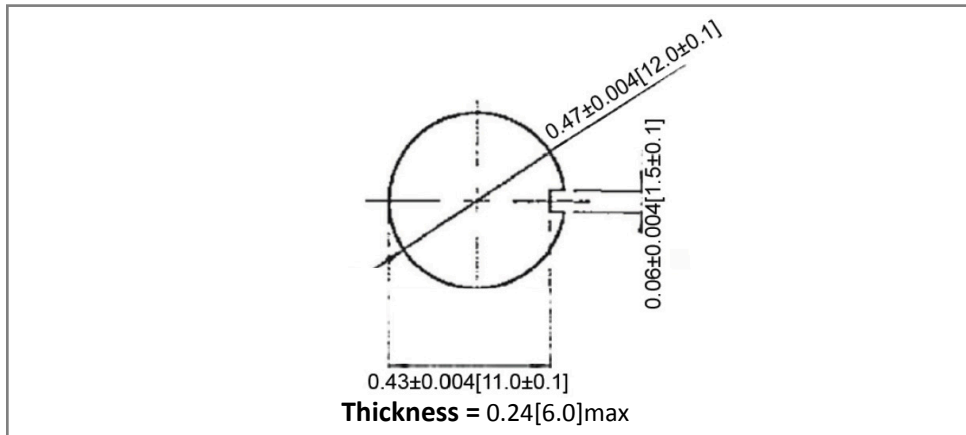

## Circuit Diagram

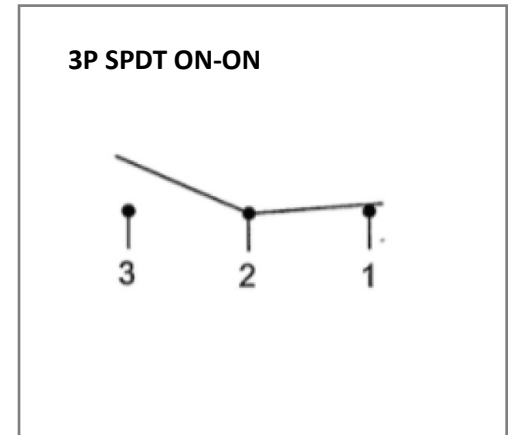

## Electrical Specifications

Rating	20A 125V AC, 10A 277V AC, 3/4HP 125-250V AC 12(4)A 125/250V AC
Contact Resistance	50m ohm Max
Insulation Resistance	DC 500V 100M ohm Min
Dielectric Strength	AC 1500V 1 minute
Operation Temperature	-20°C ~ 85°C

## Material Specifications

Operation Force	700gf $\pm$ 250gf
	1 Hex Nut Assy
	1 Knurl Nut Assy
	1 Internal O-Ring

Rev	Date of issue	Revision Notes	Designed	Approved
A	11-29-2021	Initial Drawing	RC	OF