

Mechanical Dimensions: Inches [mm]

Tolerances ± 0.012 [0.3] Unless Otherwise Specified

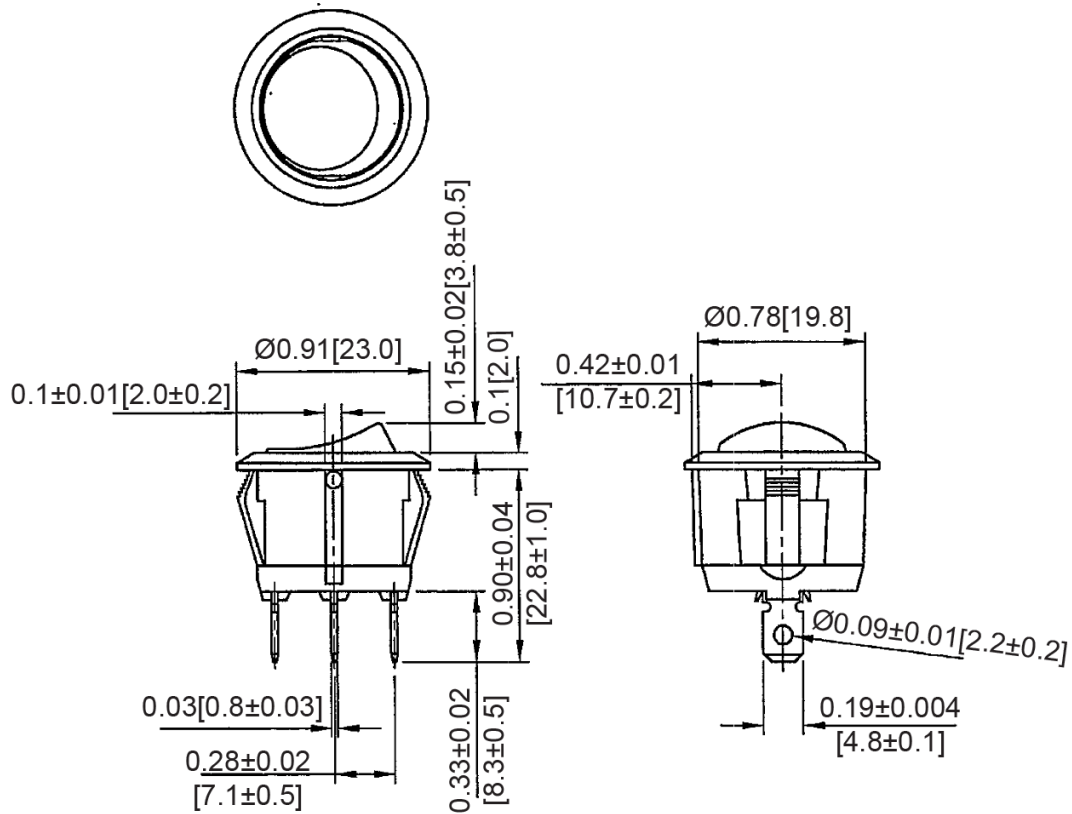

Mounting Hole

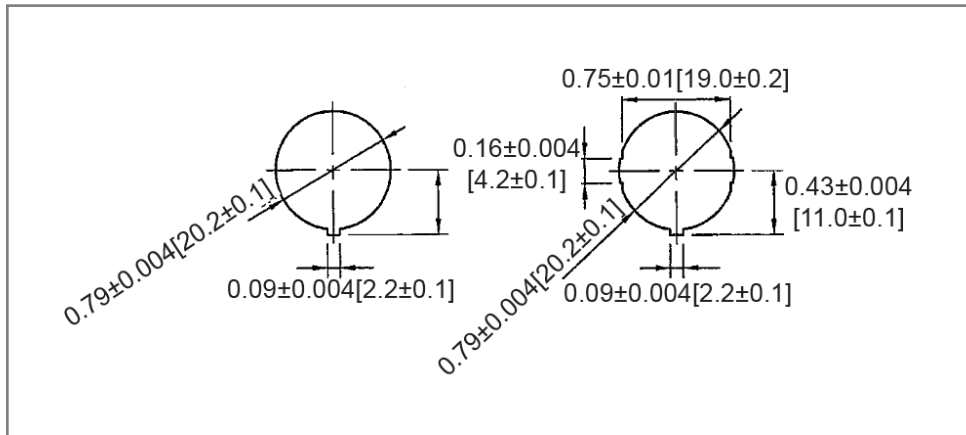

Circuit Diagram

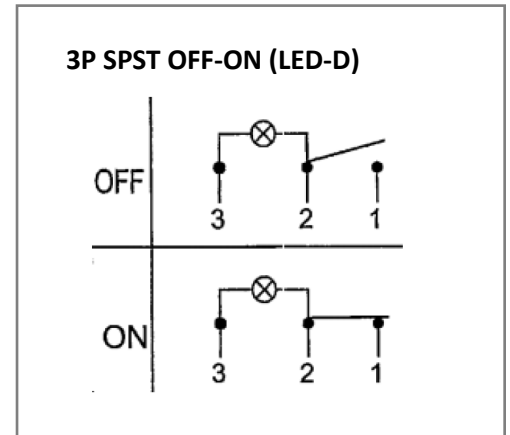

Electrical Specifications

Rating	20A 14V DC
Contact Resistance	50m ohm Max
Insulation Resistance	DC 500V 100M ohm Min
Dielectric Strength	AC 1500V 1 minute
Operation Temperature	-25°C ~ 85°C

Material Specifications

Frame	Black, Nylon 66 (94-V2)
Actuator	Yellow clear, PC
LED	Yellow (Bulb dependent)
Terminals	Silver plated, Copper alloy

Rev	Date of issue	Revision Notes	Designed	Approved
B	07-13-2021	Initial Drawing	RC	OF